



SIEMENS

Ingenuity for life



**GEOMETRIC
SOLUTIONS**



Siemens PLM Software

NX for shipbuilding

An integrated environment for
design, planning and manufacturing

[siemens.com/nx](https://www.siemens.com/nx)



Shipbuilders are being called upon to improve their designs to be more energy-efficient, reliable and environmentally friendly, with better overall performance and lower total operating costs.

Enhanced expectations



It is a formidable task to develop highly complicated ships and offshore structures while facing intense competition and price pressure as well as meeting all operational requirements over their service life. Vessels and offshore structures must endure the long-term effects of deep water environments. They are all unique or built in small production runs, are highly customized, have enormous amounts of data and require advanced production technology.

As a consequence, operating, maintaining and overhauling advanced ships can cost several times the purchase price, so new shipbuilding programs must meet goals for the total cost of ownership as well as requirements for capacity, performance and safety.

Streamlining the design process with NX

NX is fully integrated with Teamcenter® software, the world's leading product lifecycle management (PLM) system.

In the next-generation digital enterprise environment, shipbuilders require design and management systems that can be used to effectively work with enormous amounts of data while enabling efficient design of entire classes of ships. NX™ software is built on the component-based architecture of Siemens PLM Software, a technology for the design and management of large classes of products having millions of components spanning a large volume of space.

Siemens PLM Software's component-based technology allows shipbuilders the flexibility to organize ship data in multiple views, and empowers designers to rapidly search, retrieve and work collaboratively on the

end-to-end systems that pass through common ship spaces. NX is fully integrated with Teamcenter® software, the world's leading product lifecycle management (PLM) system. NX is also integrated with Simcenter® solutions to provide industry-leading simulation tools and Tecnomatix® digital manufacturing solutions to ensure optimal manufacturing planning.



Providing a focused environment

Shipbuilders must enhance productivity across the enterprise.

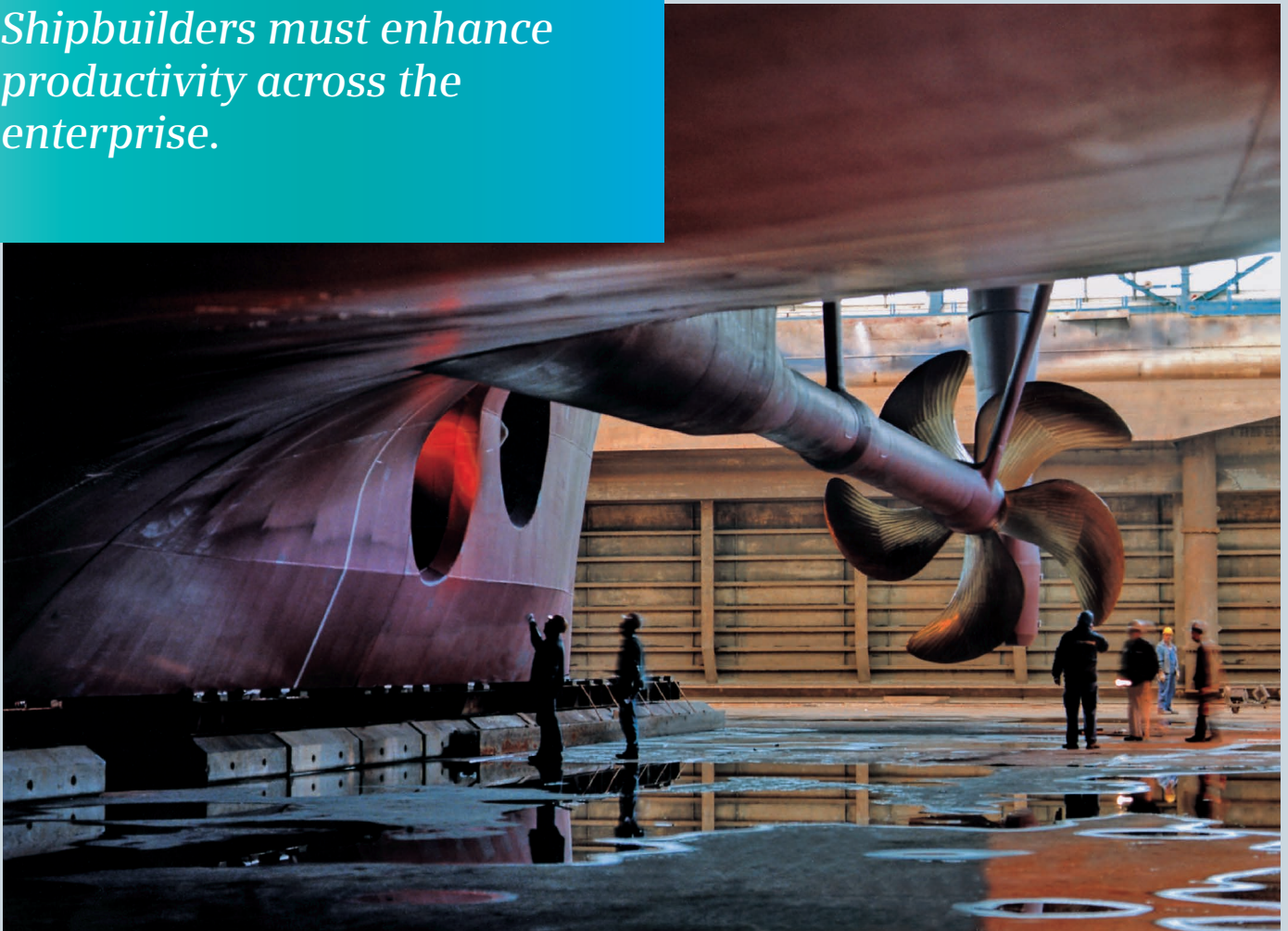

To remain competitive, shipbuilders must enhance productivity across the enterprise by achieving operational alignment as well as improving the processes used in managing ship design, construction, delivery and service. By creating a seamlessly integrated

and synchronized enterprise that links designers, engineers, production planners, production specialists, support teams, partners and suppliers, shipbuilders can improve performance, maximize lifecycle productivity, and sustain competitiveness.

Enhancing the design process

The model can also be used to create photorealistic renderings and walk-through animations to communicate the design to potential customers.

NX Ship General Arrangement Design
 NX Ship General Arrangement Design provides a focused environment for the design of the 3D arrangement of a ship. It enables concept designers to quickly create and modify ship compartments and the arrangement of equipment and standard parts within those compartments. Doors and hatches are placed as needed to provide compartment access. General arrangement drawings, tank plans and access way drawings can be created from the 3D model. The model can also be used to create photorealistic renderings and walkthrough animations to communicate the design to potential customers. The 3D model is then used as the basis of system diagram creation, distribution system modeling and structural system design.

NX Ship Structure Basic Design
 NX Ship Structure Basic Design uses the concept of a structural system to enable the user to quickly create and modify a macro view of a ship structure to support early design stage analysis, drawing generation and easy transition to detail design. The structural system concept enables the user to define decks, bulkheads and the hull as single topologically-related objects that are subdivided into subsystems that can have different material and scantlings. These subsystems are further subdivided by straking seams to define parts for manufacturing. Material estimates, unfolded minimum rectangles, and weights and centers can be calculated based on the structural systems.

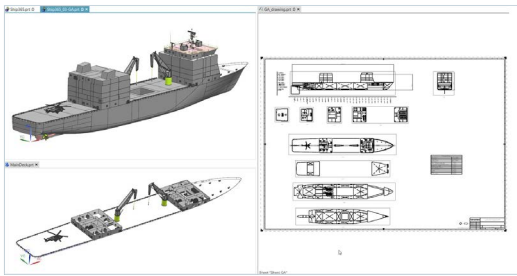
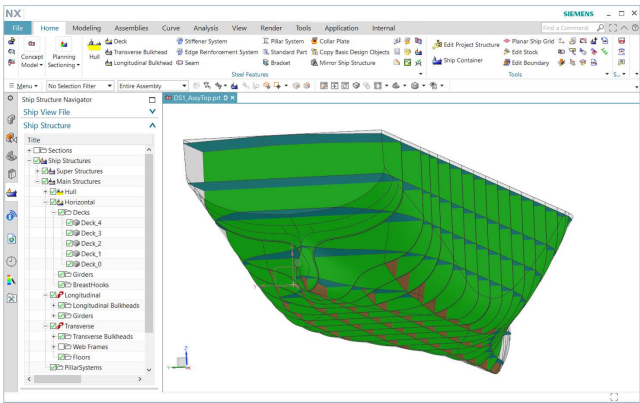
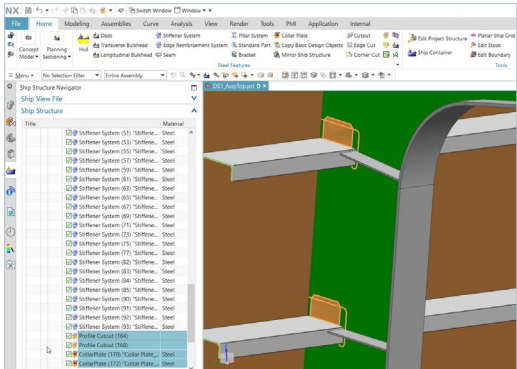
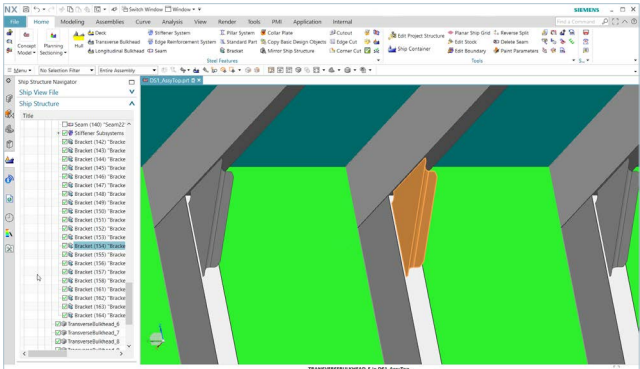

Improving design and manufacturing productivity

NX Ship Structure Detail Design

NX Ship Structure Detail Design provides all of the functionality necessary to define and modify a detailed 3D model of ship structure. It includes parametric detail feature definition for quick placement and modification of brackets, openings, profile cutouts, clips and collars, chamfers, end cuts, corner features, edge features and flanged plates. Detail Design and Basic Design both provide intelligent copy and copy-mirror functionality that maintains the relationships within the objects being copied. They also support the creation of section and expansion drawings.

NX Ship Structure Manufacturing

NX Ship Structure Manufacturing provides the ability to create the data necessary for fabricating structural parts. Manufacturing parts are generated from detail design parts, and can be easily updated when design parts change and have their own lifecycles. Manufacturing parts can include unfolded plate geometry, profile inverse bending curves, profile sketches, excess material, fit-up, marking lines, forming lines, reference lines, edge preparation, shrinkage and extensible markup language (XML) output. NX Ship Structure Manufacturing also provides plate bending templates, pin jig definition and profile sketches. It includes automated tools to create the leaf level of the manufacturing assembly hierarchy and graphic tools to create and edit the remainder of the hierarchy.

NX Ship Structure

Manufacturing also provides plate bending templates, pin jig definition and profile sketches.

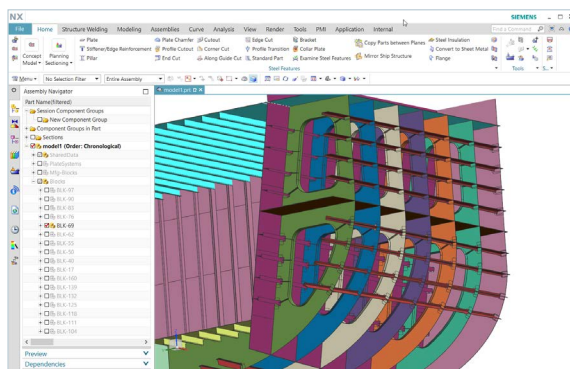
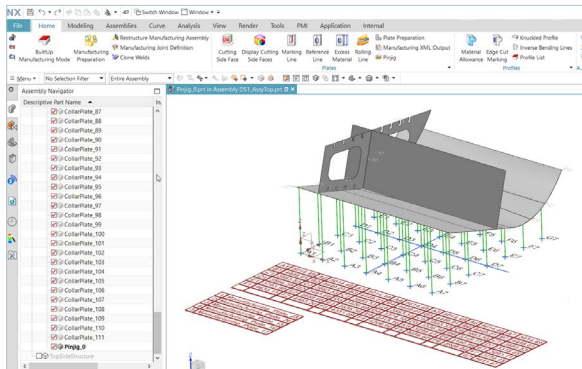
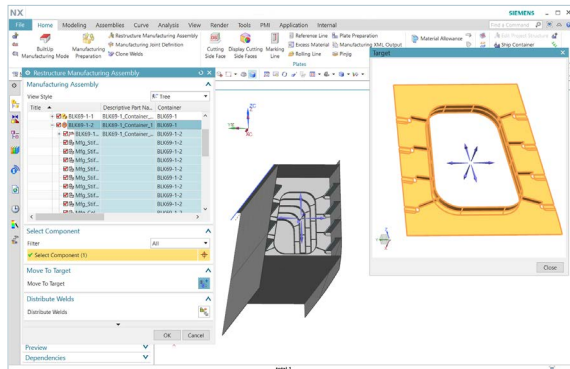

Providing specific functionality for shipbuilders

NX Platform Design

NX Platform Design enables the design of equipment support structures, access ways, walkways, maintenance platforms and similar steel structures. It maximizes design productivity for modeling platforms, plating of platforms, reinforcements, corner conditions, handrails, stairs and ladders.

NX Rules-Based Structure Welding

The NX Rules-Based Structure Welding application automatically locates, creates and manages welds in the 3D model. It uses customizable rules to determine where a weld is needed, and creates a weld joint for each weld based on the materials, thicknesses and geometry. The weld joint contains weld length and volume, bevel and fillet data, and inspection requirements, and can be

used to manage the entire lifecycle of the weld. The weld joint data is used by structure manufacturing to automatically apply edge preparation and to generate drawing and product and manufacturing information (PMI) weld symbols.

NX Penetration Management

NX Penetration Management facilitates communication between the outfitting and structure designers and automates the creation and modification of outfitting structural penetrations. It uses the Teamcenter change management system within NX to manage a customizable process for change requests, reviews, and modifications.

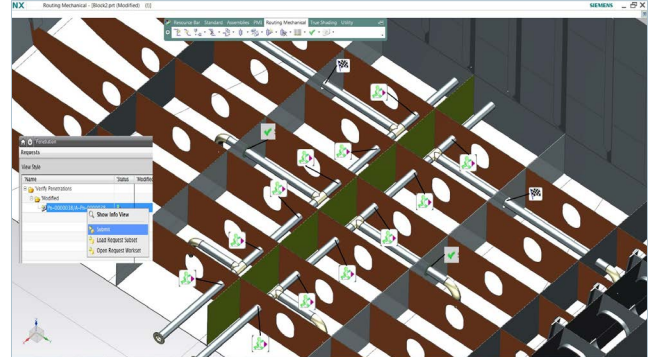
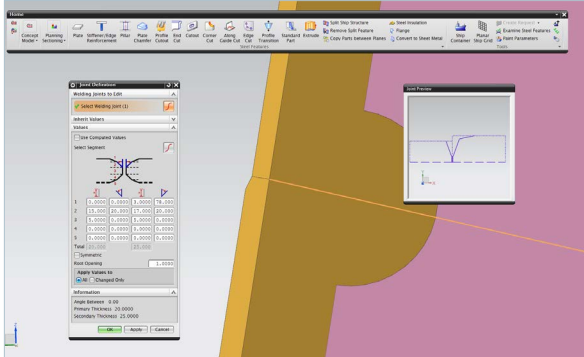

NX Platform Design provides tools to efficiently create secondary steel structure used in outfitting.

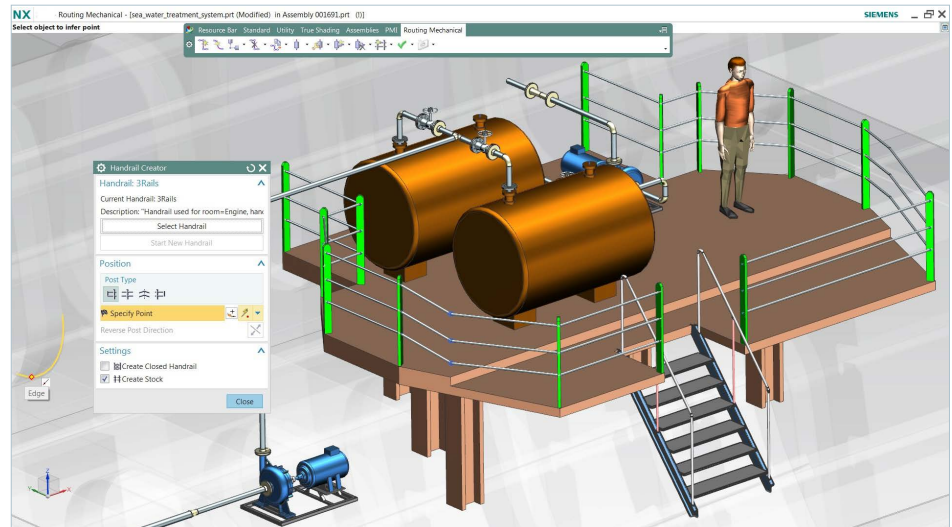

Ensuring functional and physical compatibility

NX P&ID Designer

NX P&ID Designer provides tools for the 2D layout of piping runs. This capability enables an intelligent, logical definition of pipe runs that drive downstream 3D piping design. Piping specifications, a catalog of International Standards Organization (ISO) symbols, a flexible and configurable annotation and tagging system combined with highly productive path creation tools provides a complete set of capabilities to create, edit, document and validate logical piping diagrams and associated equipment and instrumentation.

NX Routing Piping and Tubing

NX Routing Piping and Tubing provides 3D tools for creating, modifying, validating and

documenting the design of piping and tubing systems. It enables the optimization of piping and tubing design workflows through intelligent path creation, specifications-driven part selection, smart part placement, collision detection, weight calculations and rules that concurrently validate designs against company and industry standards. The software supports both rigid and flexible pipes and tubes. Designers can accelerate the routing process by leveraging runs created in NX P&ID Designer directly in 3D, and a link between diagramming and routing enables users to graphically see the relationship between the two disciplines. Together with NX P&ID Designer, it enables users to create and manage intelligent designs that ensure functional and physical compatibility.

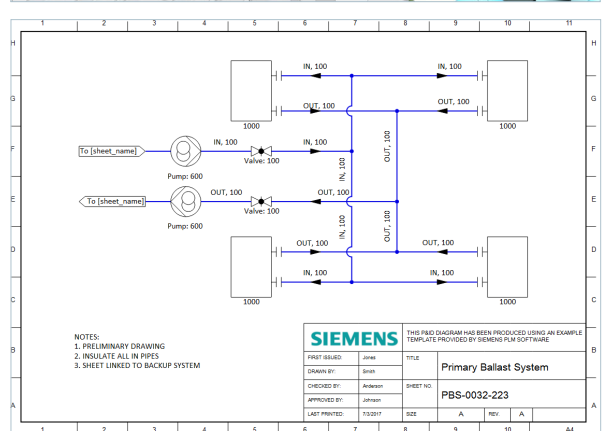
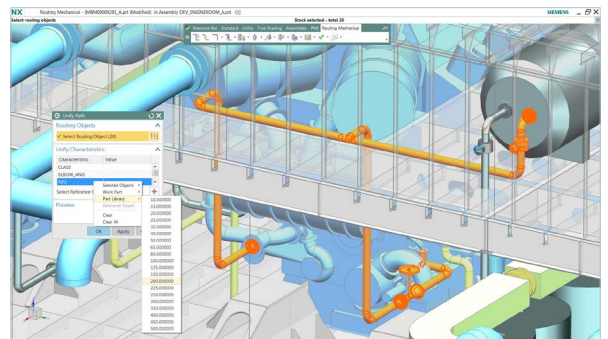
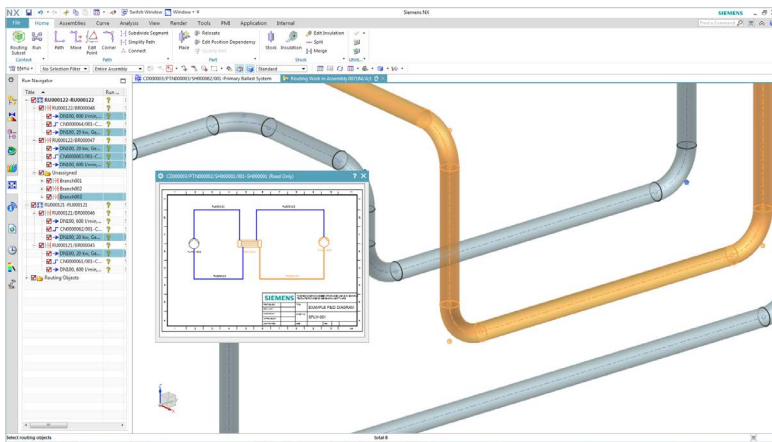

Designers can accelerate the routing process by leveraging runs created in NX P&ID Designer.

Delivering a lifecycle solution for HVAC design

The software supports a predefined catalog of HVAC parts and parametric templates that can be modified on-the-fly (smart sizing) to fit any space constraints.



NX Routing HVAC

NX Routing HVAC provides 3D tools for creating, modifying, validating and documenting heating, ventilation and air conditioning (HVAC) systems design. It enables the

optimization of HVAC design workflows through intelligent path creation tools, specifications-driven part selection, smart part placement, collision detection, weight calculations, duct splits, duct size calculators and knowledge rules that concurrently validate designs against company and industry standards. The software supports a predefined catalog of HVAC parts and parametric templates that can be modified on-the-fly (smart sizing) to fit any space constraints. Together with other NX capabilities, such as hangers and sheet metal flat patterns, the software provides a complete lifecycle solution for HVAC design.

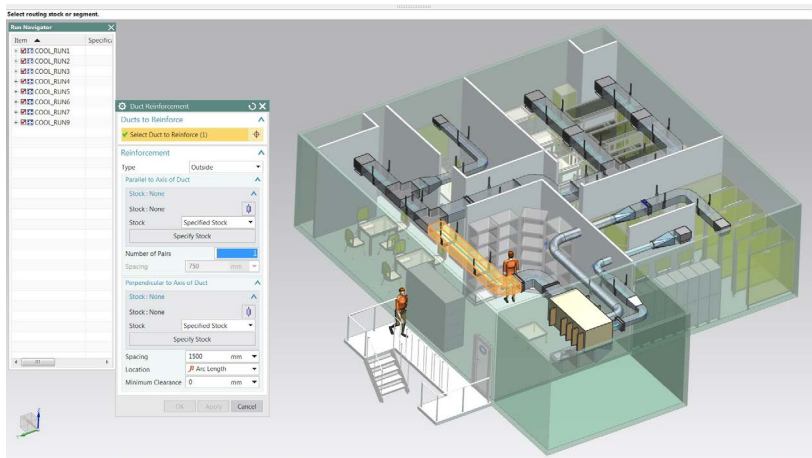

Enhancing cable routing with NX

NX Routing Cabling

NX Routing Cabling provides the tools needed to route electrical cables in product assemblies via typical mechanical parts, and supports equipment such as conduits and raceways. The software can import a list of cable descriptions for connections between electrical devices. This connection list may be created from a 2D logical design application, such as NX Schematics or various other external electronic computer-aided design (ECAD) applications.

Using NX Routing Cabling, you can automatically find paths that have been routed between the devices, and can assign the cable descriptions to the path segments. The cable descriptions define the cable diameters and can be used to create solid cable models. Actual cable lengths and diameters may be automatically added to the connection list for feedback to upstream ECAD applications or downstream to manufacturing applications.

NX Routing Cabling also identifies rule violations, such as minimum bend radius and percent fill for cable trays and hangers.

The system provides for the production of design documentation, such as 2D representations of the cable tray layout at selected points along the route.

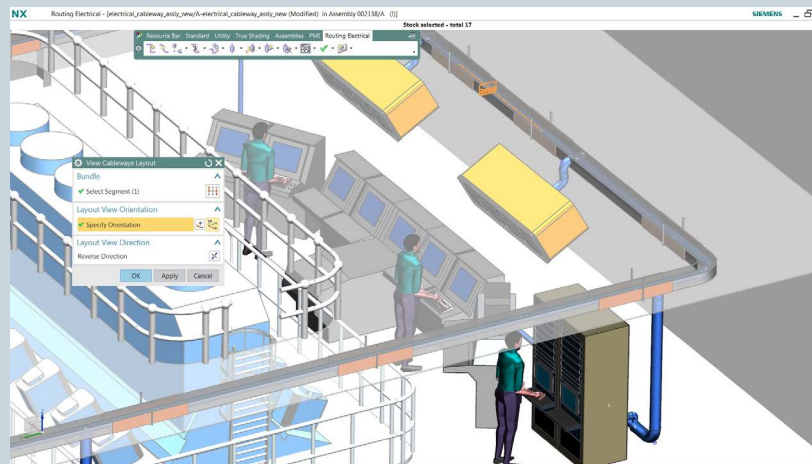
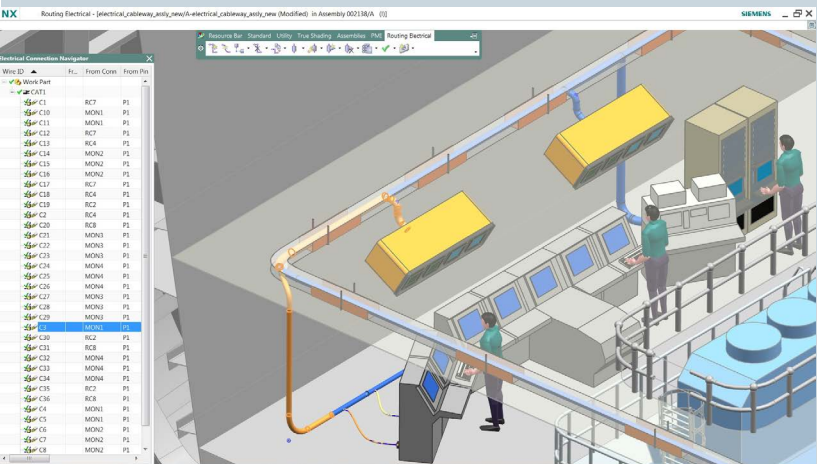
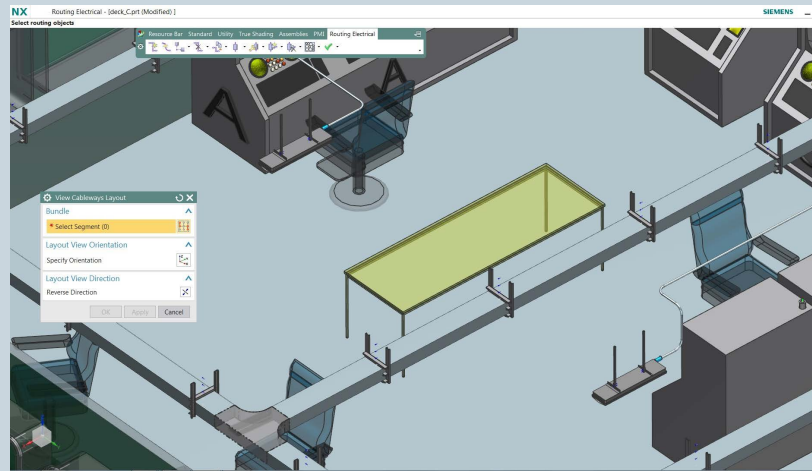

About Siemens PLM Software

Siemens PLM Software, a business unit of the Siemens Digital Factory Division, is a leading global provider of software solutions to drive the digital transformation of industry, creating new opportunities for manufacturers to realize innovation. With headquarters in Plano, Texas, and over 140,000 customers worldwide, Siemens PLM Software works with companies of all sizes to transform the way ideas come to life, the way products are realized, and the way products and assets in operation are used and understood. For more information on Siemens PLM Software products and services, visit www.siemens.com/plm.

Headquarters: +1 972 987 3000
Americas: +1 314 264 8499
Europe: +44 (0) 1276 413200
Asia-Pacific: +852 2230 3308

© 2018 Siemens Product Lifecycle Management Software Inc. Siemens, the Siemens logo and SIMATIC IT are registered trademarks of Siemens AG. Camstar, D-Cubed, Femap, Fibersim, Geolus, GO PLM, I-deas, JT, NX, Parasolid, Solid Edge, Syncrofit, Teamcenter and Tecnomatix are trademarks or registered trademarks of Siemens Product Lifecycle Management Software Inc. or its subsidiaries in the United States and in other countries. Simcenter is a trademark or registered trademark of Siemens Industry Software NV or its affiliates. All other trademarks, registered trademarks or service marks belong to their respective holders.

43759-A19 8/18 A



844-GEO-SUPT
support@geoplms.com
geoplms.com