



SIEMENS

Ingenuity for life



**GEOMETRIC
SOLUTIONS**

What's new in NX 12

Next-generation solutions for design, simulation and manufacturing within a single software system

NX 12 for product design benefits

- Leverage convergent models in downstream applications like MBD
- Design lightweight parts and verify designs for additive manufacturing
- Significant improvements in assembly performance
- New dedicated tools for process-specific design such as NX Animation Designer and NX P&ID Designer
- Easier creation of math-based models supports generative design
- Automatically determine accurate tooling costs early in the design phase
- Improved ship design efficiency and versatility
- Easier transition to drawingless workflows with Convert to PMI
- Deeper integration with Teamcenter
- Display multiple windows in a single NX session to better facilitate multi-tasking and cross-checking

Summary

Building on its legacy of best-in-class customer deployment readiness and data preservation, the latest version of Siemens' NX™ software and Simcenter 3D software (NX 12) delivers the next generation of design, simulation and manufacturing solutions that enable companies to realize the value of the digital twin in the end-to-end process. The challenges of today's market – from increasingly complex products reliant on integrated electronics to ever-decreasing lead times – can only be met with truly open, integrated software that unites the best tools in a single platform.

NX 12 for next-generation design

Summary

NX 12 for product design delivers major enhancements in key areas, including Convergent Modeling™, design for additive manufacturing and process-specific tools. The new capabilities not only provide a new level of efficiency, they also enable designers to create breakthrough products.

Modeling

NX gives you more options than any other solution to create the geometry you need to design your next-generation products. From Convergent Modeling to synchronous technology to surfacing, parametric modeling, and more, NX always has the right tool to get the job done right the first time.

Convergent Modeling

Convergent Modeling is a game-changing tool in NX that allows you to modify and work with facet geometry the same way you work with traditional CAD geometry. NX 12 builds on this foundation with a number of significant enhancements. NX 12 makes it easier to select the facet geometry you need, as well as merge and divide facet faces. New tools enable you to clean up a facet body for downstream use much more easily than before. You can now offset entire facet bodies or portions, and create chamfers and blends on them as well. Together, these enhancements extend the already-groundbreaking capabilities of Convergent Modeling in NX to new heights.

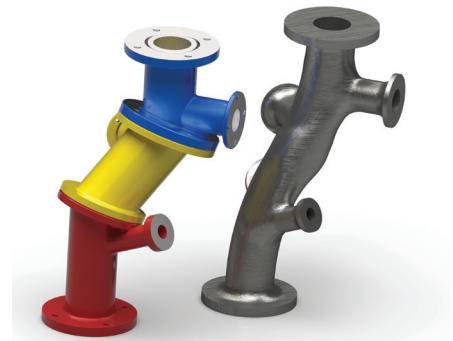

Convergent Modeling helps you create optimized shapes.

What's new in NX 12

Simcenter 3D v12 benefits

- Reduce part weight and increase strength through new topology optimization in NX Nastran
- Bring legacy mesh data to life by converting it into editable, Convergent geometry
- Simulate even more types of physics and complex assemblies with advanced solutions for structural dynamics, motion, acoustics and more
- Solve models that experience large deformations and contacts with expanded nonlinear solutions
- Simulate composites for ply damage and manufacturing processes like curing
- Perform industry-specific applications with enhanced workflows for air-frame, automotive, and spacecraft engineers

NX 12 for Manufacturing benefits

- Reduce machining cycle time by up to 60 percent with Adaptive Milling, a new high-speed roughing strategy
- Simplify 5-axis programming of complex hollow and narrow features with the new Tube Milling
- Distribute, balance, program and simulate operations over multiple machines with NX Machining Line Planner
- Automate processes using robots to perform machining and pick-and-place operations
- Prepare complete 3D printing jobs for a range of industrial powder bed fusion printers
- Print functional plastic parts easier, faster and more accurately when HP 3D printers are combined with NX

Design for Additive Manufacturing

Additive manufacturing is more important than ever in product design. NX 12 gives you the tools to design light-weight parts by filling a volume with a lattice structure, helping you optimize your design for additive manufacturing, reduce material use and meet weight requirements without compromising the strength or robustness of your design. It's also much easier to make sure that your design is built right the first time. By identifying build issues early, you can get from design to build much faster.

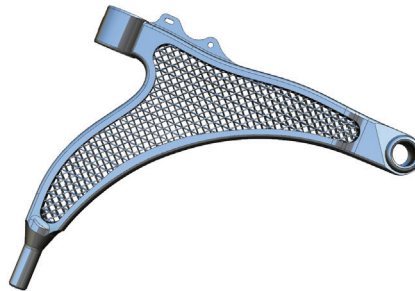

Lattice structures save weight and maintain strength.

Productivity

NX 12 delivers a number of feature editing and creation enhancements that drive productivity improvements. For example, you can now see the feature section direction when creating, editing, or replacing features. You now have the option to retain or delete child features when deleting features. This gives you more control over how your features are linked, and makes it easier to change or update your model.

Drafts and blends are critical to creating a finished, manufacturable design, but they can sometimes cause issues when updating or changing your model. In NX 12, these features have been made considerably more robust, so they adapt better to changes and perform better than before, even with highly complex models.

Surfacing

Section surfacing in NX 12 is significantly upgraded with a new lofting engine that improves the quality and accuracy of your section surfaces, along with a 95 percent improvement in performance. In addition, customer-driven improvements make surfacing more robust and powerful than ever, improving update performance and making it easier to get the geometry you need. The surface flattening and forming capability in NX 12 is enhanced to give you more control over distortion, making it easier to flatten complex shapes without distorting them in the process.

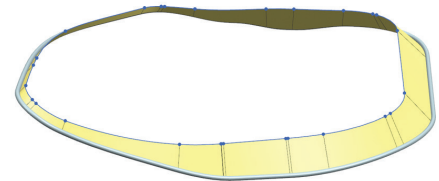

Section surface performance is improved by 95 percent.

Assemblies

NX 12 delivers a major improvement in assembly performance in managed mode with Teamcenter. Extensive updates to the way assemblies are handled mean that they load much faster than ever before and use less memory. Not only does this save time, it makes it easier to work with large assemblies, and the smaller memory footprint means that you can load larger models than ever before. In addition, your assembly geometry is displayed during the load process. Please note that you will need Teamcenter 11.3.0.1 or later to take advantage of these improvements.

Mockup

There is a new dedicated design mockup (DMU) application in NX 12. By clearly separating the reviewing environment from the authoring environment, you can make changes to the mockup without having to worry about modifying the base geometry. That means you can feel free to experiment with your geometry and explore solutions to find the optimal one.

Process-specific design

Process-specific design applications in NX include Animation Designer, P&ID Designer, process automation, Mechatronics Concept Designer, joining and welding, sheet metal, tooling design, and shipbuilding. These areas have undergone extensive updates to improve workflow efficiency and versatility.

Mentor Graphics integration

Mentor Graphics has recently become a Siemens business, and NX 12 integrates Mentor's electrical design tools into NX. These tools break down the barriers between the ECAD and MCAD domains, helping you collaborate more easily and work from a single set of data. Capital is an electrical system and wire harness design tool, and in NX 12, it allows you to do electrical design work in the NX environment, including live cross-probing between logical and harness models and harness space reservation. Xpedition enables cross-discipline PCB design in NX. This means that you can embed your electronic design into your mechanical layout with the ability to view, markup, and cross-probe from either side. These tools make it easier and faster to design the next generation of products with integrated electronics.

NX Animation Designer

NX Animation Designer is a fully integrated tool that lets you animate almost any type of geometry, from sketches to part or assembly bodies, and even imported data. It's easy to use: you simply define what can and can't move, define the joints, couplers, and motors, put the movements into a timeline structure, and press "play." Automatic collision detection helps you find kinematic issues with your assembly without the need to build costly physical prototypes, and because you can quickly change your geometry in the same environment and run the animation again, you can do multiple design iterations quickly, leading to higher-quality products.

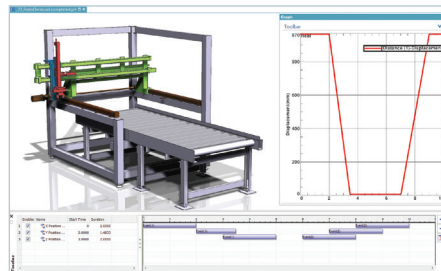

NX Animation Designer helps you find kinematic issues early.

NX P&ID Designer

NX P&ID Designer software is a 2D piping and instrumentation diagramming tool that helps you create functional or logical designs of piping and instrumentation systems. It is easy to use, with drag-and-drop component and pipe placement and editing, and automatic placement of things like nozzles and jumpers. In addition, you can verify the quality of your design by using proven components from a library that ensures that the right components

and equipment are used in both the detailed design phase and in manufacturing. Real-time connectivity validation also helps you make sure the design is right the first time. Finally, the smart 2D diagram is used to create 3D routing components, saving time and translation. NX P&ID Designer helps you spend less time on the diagram and more time on making sure you have the optimal design.

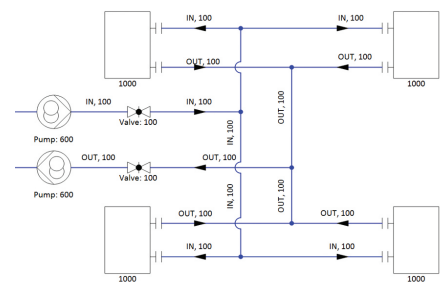

NX P&ID Designer offers easy design and validation.

Process automation

Process automation tools in NX 12 have more options and power for helping you create advanced math-based models. Integration with Maple and Symbolica means that you can not only drive NX expressions with worksheets, but also include the properties of your NX model in the worksheets, for bi-directional communication. The new "body by equation" feature lets you take advantage of the 3D plotting functions in the math-based tools to create a convergent body that remains associative to the worksheet. This capability ensures that there is no deviation from the shape defined by the equations, and makes it easier to use the shapes in downstream applications.

Mechatronics Concept Designer

Mechatronics Concept Designer (MCD) is enhanced in NX 12 to be more powerful and easier to use. The Mechatronics Collaboration Structure enables automation engineering for all designs authored with NX, regardless of which NX application was used. In addition, operations in MCD are now controlled by the same timeline interface as the rest of NX. These enhancements make it much easier to collaborate across engineering domains in NX. The physics you use to define machine tools and material handling in MCD have also been improved. Finally, MCD now has new runtime interfaces that make it easy to connect to third-party applications and devices.

Welding and joining

NX 12 features a number of welding and joining enhancements that save time and reduce errors. It is now possible to create weld joints that are independent of the position of their source geometry. This means that if the source changes, there's no need to go through and repair the links. You can also generate a series of joints, such as spot welds, by specifying a minimum distance between the start and end points; NX automatically places the welds, eliminating the need for manual calculation. By expanding the weld transformation function to include all types of arc welds, you can move or mirror your welds more quickly. Feature groups of discrete joint types provide a way to organize your joint data that can be tracked in the part navigator, so you spend less time trying to find joint data. It's also easier to determine discrete joint types with 30 new marker symbols. Together, these enhancements deliver improved automation that saves time and improves clarity to reduce errors.

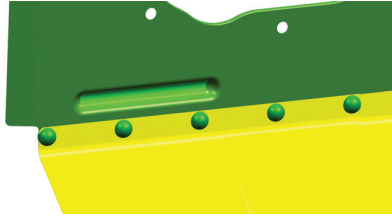

Spot weld creation is easier in NX 12.

Sheet metal

Sheet metal design has a number of customer-driven improvements in NX 12. You now have more options for creating flat patterns, giving you more flexibility to work the way you want to. There are more options available when converting a solid part to sheet metal, leading to cleaner geometry and easier downstream use. Reduce the number of flange features in your sheet metal parts with new functionality, yielding faster updates and improved productivity. Design in the context of your larger assembly by creating tabs that can be constrained to reference faces from the assembly, improving associativity and reducing errors. In NX 12, your materials can be used to select the correct tools for each bend, automating the bend process and making it easier to create manufacturable parts the first time. One of the core values of NX is that your legacy data is always protected. The renew feature capability in NX 12 will update a legacy sheet metal feature created in an earlier version of NX to the latest version, eliminating the need to manually recreate the feature to take advantage of enhanced functionality in the latest version.

Routing

Continuous improvement in electrical and mechanical routing in NX 12 means that attributes maintained by the routing application are easier to use and more capable, making it easier to access the information you need. Maintaining standard parts and creating spline paths is also easier. The new bend radius table function makes configuration easier and faster, and supports downstream use of attributes in areas like product and manufacturing information (PMI). You can now place elbow parts with one step, which not only saves time, but also matches common routing workflows.

Next-generation routing takes advantage of 4th Generation Design (4GD) to provide breakthrough management and productivity for large routing systems. You can create paths in P&ID Designer, manage them in Teamcenter, and fulfill them in NX. Working in a managed environment improves productivity and makes feedback easier. Change workflows are more efficient, reducing the need for rework and duplicate changes.



Easier attribute tracking in routing

Tooling design

Tooling manufacturers can now automatically and accurately determine tooling production costs using the new integrated capabilities of Siemens PLM Software solutions. The digitalized process, from part design to tooling cost estimate, can replace the time-consuming manual job tasks. This process gives tool manufacturers a unique advantage in a highly competitive industry.

NX Feature2Cost can automatically identify features on molded or stamped parts using the robust feature recognition capability. It lets you easily recognize many part features, such as undercuts, ribs and bends. During the cost calculation process, NX also gives you flexibility to apply your experience to achieve best results.

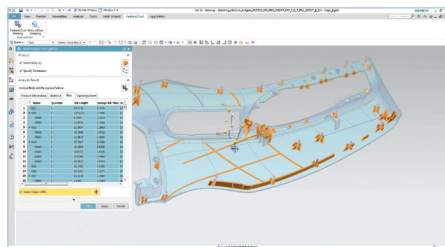

Automatically recognize features on molded and stamped parts, including undercuts, ribs and bends using NX Feature2Cost.

The complete set of recognized features along with their parameters is seamlessly transferred to the Teamcenter product costing solution. After providing additional information such as the production site and machines, the software can precisely calculate the tooling cost. By being able to quickly provide accurate quotations, tooling manufacturers are positioned to win more orders and increase their profitability.

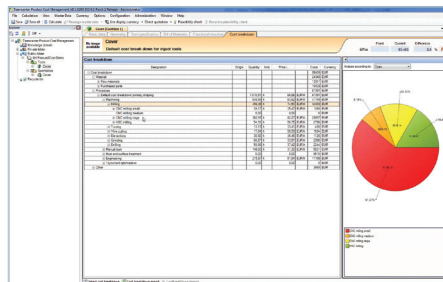

Accurately determine the tooling costs using the powerful Teamcenter product costing solution.

The rough offset command now enables you to control the offset direction and create a convergent body that is fully associative to the original geometry. There have also been a number of usability improvements that save you time. For example, Mold Wizard now reads the material specified in NX, reducing manual work and improving accuracy.

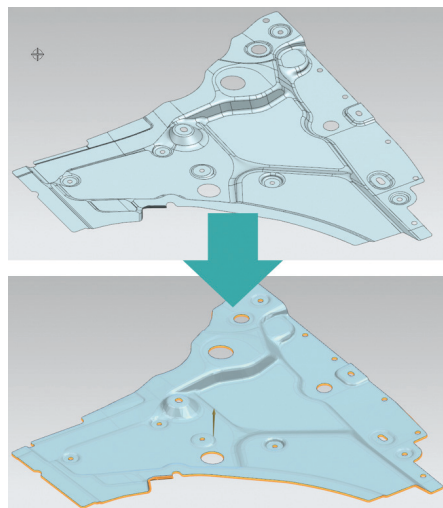

Rough offset creates a fully associative convergent body.

Customer-driven improvements in Mold Wizard improve consistency and productivity. Re-using attributes from the top-level component ensures consistency from design to downstream manufacturing processes, and automates bill of materials (BOM) creation. NX helps you analyze cooling circuits to determine flow, and in NX 12, the process is more automated, eliminating many manual steps.

Progressive Die Wizard also features a number of productivity-driven enhancements in NX 12. Improvements to split inserts, die base designs, and ramp shank creation save time by automating many manual tasks, and reduce errors by tracking and re-using attribute information from the source part.

Shipbuilding

Marine design and shipbuilding in NX 12 has a number of enhancements, including some to basic and detail ship design. It is now faster to start a project using a standard project template. In NX 12, you can save time by creating ship grids from spreadsheets, and the grid display will automatically size correctly, improving comprehension and understanding. Performance improvements make it up to two times faster to transition between basic and detail design. Support for the common naval global coordinate system means that it is easier to comply with industry standards.

In NX 12, ship structure basic design improvements deliver more efficient and versatile workflows. Stiffeners and edge cuts are easier to create and more versatile, and validation tools help to ensure the quality of your design.

Some shipbuilding enhancements cover both basic and detail design. With the added ability to create custom shapes to the “cutout” command, you can eliminate several manual steps and have more flexibility in how you work.

Enhancements to ship structure detail design include more options for splitting ship structure items, making it easier to work the way you want and improve efficiency. More options for penetration management eliminate manual workarounds and improve versatility. New tools for defining the manufacturing build-up of the ship structure automate many formerly manual tasks and make the entire process more efficient.

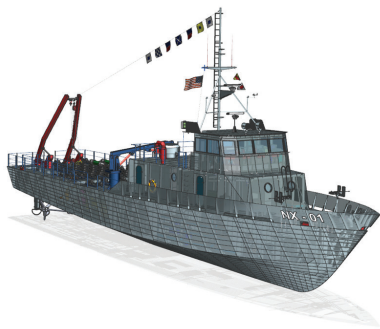

Multiple enhancements make ship design faster and easier in NX 12.

Model based definition

Model-based definition (MBD) powered by NX PMI enables you to put your critical information directly on the 3D model, enabling downstream re-use and reducing errors and rework. NX Drafting helps you create detailed drawings from your 3D models.

MBD

In NX 12, PMI is easier to use than ever with support for multiple display parts, giving you more freedom to use the workflow that best supports you by displaying multiple windows within one NX session. Important functionality enhancements in NX 12 for PMI include the ability to create a table that displays information for PMI objects and attributes, which is valuable for many downstream applications. More bolt circle options and the ability to suppress PMI objects give you more control over your annotation and more versatility in your workflows. Together, these make it easier to transition to a drawingless system.

Convert to PMI, introduced in NX 11, automatically converts drawings and views to PMI objects, saving significant time when leveraging legacy data. In NX 12, more objects are supported, and enhanced workflows help you take advantage of MBD and its downstream re-use capabilities.

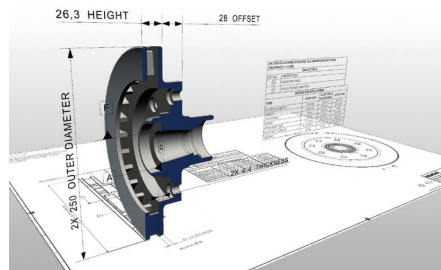

Convert to PMI helps you create annotated 3D models from 2D drawings.

Some annotation-related enhancements apply to both NX PMI and NX Drafting. For example, you can now apply PMI to convergent bodies or create drawings based on them. This capability accelerates the concept-to-production workflow by taking advantage of different types of modeling data from multiple sources. PMI and drafting also support minimally loaded assemblies, which load only necessary geometry but still maintain visibility of annotation. This capability improves system performance, particularly with large assemblies. New dimensioning options give you more flexibility to accomplish your work. Feature control frames now have more indicator options to better support industry standards. New angular directed dimensions in NX 12 indicate the direction of angular measurement, improving clarity and reducing the chance of errors.

NX Drafting

Drafting-specific enhancements in NX 12 include the ability to extract modeling points associated to the model when including model curves in your drawings, saving manual work and improving productivity. More options when creating section component attributes are designed to support the way you work.

NX Layout

NX Layout is a powerful 2D concept design application within NX. With no need for drafting sheets, it is now easier to place 2D components with constraints, saving time and increasing workflow versatility.

Teamcenter Integration

Deeper integration between NX and Teamcenter makes it easier than ever to collaborate both within and outside your team.

NX Teamcenter interface

NX and Teamcenter are more closely aligned than ever in NX 12. For example, you can do intelligent saves, which help you decide what type of save operation to perform on objects you may not have full write permission for. NX environments make it easier to work with partners using different versions of NX. Publishing model views into Teamcenter makes it easier for non-NX users to access your data using JT™ data format viewers or other tools.

NX 12 supports multiple types of lists of values (LOVs) inside NX. In NX 12, the Precise Structure Column display has been made more consistent with the Teamcenter Structure Manager, making it easier and faster to understand the state of your objects. Multiple item naming patterns make it easier to determine the correct part in NX when dealing with duplicate names. You can import and export multi-CAD assemblies, or assemblies that contain both native NX and JT data, while preserving the associativity between parts. You can save time by changing your Teamcenter group or role without having to leave your NX session.

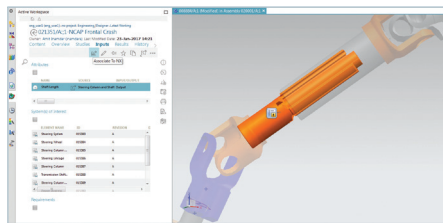

Active Workspace is one of many tools that NX users can employ to access Teamcenter information.

Systems-driven product development

A systems-driven product development process, or SDPD, combines systems engineering methodology across all development domains with an integrated definition of the product. In NX 12, you can define key fixed points in a product with the new point coordinate with deviation type. The ability to check requirements in Simcenter results broadens the types of requirement checks you can do. A new visual report for key performance indicators shows the status of your requirement checks and can be exported to a spreadsheet. You can create interface control documents more easily in NX 12 by defining the key characteristics for important geometrical interfaces in the product interface command, or by dragging and dropping a visual report.

Design limits allow you to embed knowledge in your design to enhance re-use and make future changes more easily. You can associate measurable attributes to NX item revisions to improve attribute tracking and verify the quality of your parts. When sending an analysis request, you can track logical-to-physical relationships, interact with the request through Active Workspace, read values from the logical model into NX expressions, and read Teamcenter attributes into NX validation requirements. This makes it easier to collaborate and verify your designs. Visual cross-probing between logical and physical models and between measurable attributes and CAD measurements makes it easier to trace validation results and verify functionality and quality.

User experience

The user experience in NX 12 has a group of enhancements that make NX more efficient and secure than ever before.

Multiple display parts

Multiple display parts allow you to display multiple parts in separate windows in a single NX session. This enables you to take advantage of all of your screen space and multiple monitors while quickly switching between parts using keyboard shortcuts or mouse selection. It is much easier to see how a change to a part will impact an assembly or compare two different parts with multiple windows. This functionality is available in all NX applications.

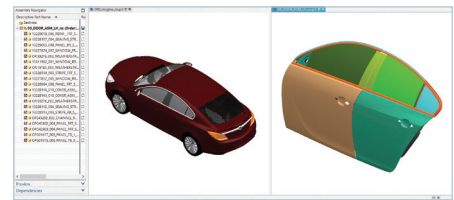

Multiple display parts help you easily compare parts and assemblies.

Gestures

New gestures in NX 12 make it easier to navigate and select what you need. For example, double-clicking in the background will fit your part to your view. A single click in the background will now deselect any selected object. These save time as there is no need for keystrokes or finding icons on a taskbar for these common tasks. You can navigate large data sets more easily with the ability to find objects in a table.

Security

In NX 12, your data is more secure than ever. You can now set passwords for your parts and assemblies in native NX mode when no data management system is being used. You can also apply different levels of access to each part or assembly. This capability makes supplier collaboration much more secure and protects your valuable intellectual property.

Product Excellence Program

NX 12 users have the option to participate in Siemens' Product Excellence Program, as a way to influence and improve future versions of NX simply by doing your normal work. This program helps Siemens understand how you use NX and where we need to concentrate our resources in the future. It is strictly optional, and any data collected is highly secured.

3D box selection

3D box selection in NX 12 makes it much easier to select geometry in 3D space and work in large, complex designs. It eliminates manual selection of each item in a given area. Continuous improvement in visualization takes advantage of the latest technology to deliver improved display quality and better understanding of your designs.

Rendering

NX 12 builds on the high-end rendering capabilities of earlier versions with new controls in the studio material editor. These tools make it easier to define textures, understand the impact of material changes before they are made, and enable faster design validation and image creation. There are also new types of materials as well as new scenes, so you can save time and reduce editing and creation of your own.



New materials enable higher-quality rendering in NX 12.

Simcenter 3D v12 for next-generation simulation

Summary

Simcenter 3D v12 advances computer-aided engineering and simulation to revolutionize how simulation engineers can help drive design direction. The latest release of Simcenter 3D introduces more enhancements than any previous release to support generative design, integrate new technologies into the unified and scalable environment, expand nonlinear solutions and enhance industry workflows for air-frame, automotive, and spacecraft applications.

Supporting generative design

Generative design is a computational process in which a design takes shape based on rapid modification and evolution of design parameters based on performance of that design and a set of goals. Simulation is at the heart of generative design processes, and the latest Simcenter 3D release introduces a number of new capabilities that in combination with NX can help you generate innovative, lightweight design ideas faster.

Topology optimization for analysts

This release of Simcenter 3D adds new topology optimization capabilities powered by NX™ Nastran® software that enable analysts to consider a deeper level of detail and analysis into the shapes they generate. For example, analysts can consider things like multiple load cases, manufacturing constraints, and where to best use lattice structures in the part. Additionally, designers and engineers can then edit the resulting shape from topology optimization through the use of Convergent Modeling for a faster concept-to-final design process.

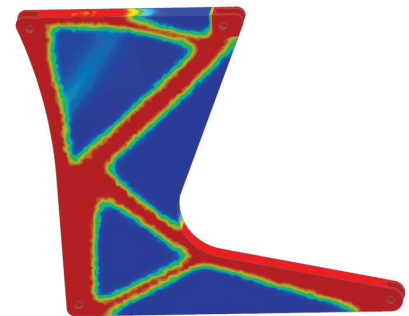

Topology optimization, powered by NX Nastran, used to reduce the weight of an airline seat bracket

Convergent Modeling for CAE

Convergent Modeling refers to the ability to edit faceted bodies as if they were typical, boundary representation (b-rep) bodies in CAD. Simcenter 3D now exposes Convergent Modeling within the CAE environment and gives you the ability bring legacy FE mesh data to life. Now you can turn legacy mesh data into a convergent body, which you can then edit as geometry. After you have made your geometry edits, you can then immediately re-mesh and re-analyze this new design. This means your designers no longer need to undertake the painstaking process of recreating geometry by hand based on legacy mesh shapes.

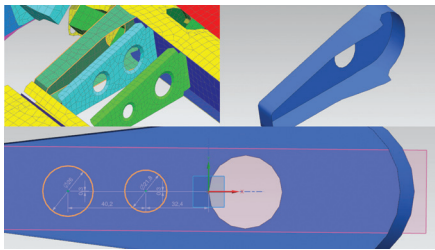

Bring legacy mesh data to life by converting it into editable, Convergent geometry.

Integration with HEEDS

Simcenter 3D can be used in connection with HEEDS™ software for design exploration and generative design processes. The portal from HEEDS will drive Simcenter 3D to make any necessary parameter changes to your analysis models so that simulations can be run and iterated to explore and achieve the defined design objectives.

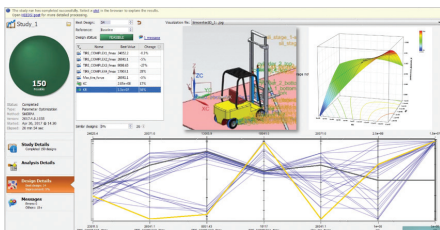

Perform design exploration using HEEDS to drive multi-run simulations in Simcenter 3D.

Technology integration

The latest release of Simcenter 3D expands and deepens the level of simulation technology available within the unified, scalable, open and extensible environment. This release includes brand new enhancements and integrates significant capabilities that were previously available in legacy simulation tools like LMS Virtual.Lab™ software and LMS Samtech Samcef™ software. Integration and expansion of these capabilities into Simcenter 3D helps you address more scenarios and problems within the same platform, thereby increasing your productivity and the return on your investment.

New in motion analysis

Motion analysis in Simcenter 3D is enhanced to now give you the ability to add working submechanisms within a larger mechanism. This capability lets you simulate more complex assemblies and systems. Other motion enhancements include new analytical contact definitions that can accelerate solution time for models where parts come into contact with each other.

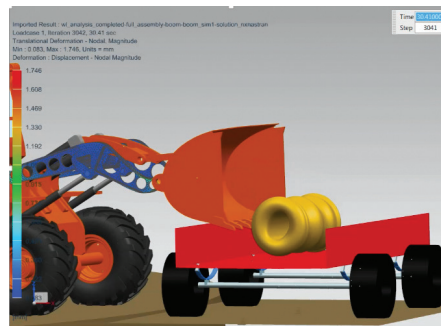

Simulate complex mechanisms that consist of multiple submechanisms.

New in acoustics analysis

Acoustic analysis in this release of Simcenter 3D introduces acoustic transfer vectors (ATV) that enable you to efficiently compute vibro-acoustic pressure at microphones. The ATV solution is useful when analyzing large models for many frequencies or rotational speeds. Additional acoustics enhancements include new acoustic sources and acoustic diffusive field, as well as new receiver scenario-based capabilities. A new finite element method adaptive order (FEMAO) option is a higher-order polynomial technique that allows you to use coarse meshes with excellent accuracy and reduced computation time.

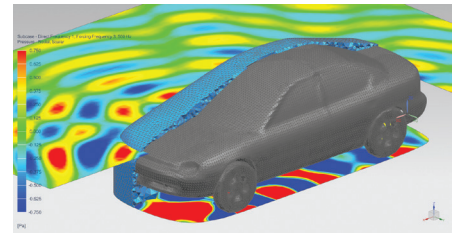

Speed up vibro-acoustic simulation using the FEM Adaptive Order acoustics solver.

New in structural simulation

Broadening nonlinear solutions and applications is a major focus for this release. The multi-step nonlinear solution (NX Nastran SOL 401) has been enhanced to become a general-purpose nonlinear solver by expanding coverage to models with shells, beams and spring elements. In addition, a new structural nonlinear dynamics solution has also been introduced into NX Nastran as SOL 402, and is supported from the Simcenter 3D interface.

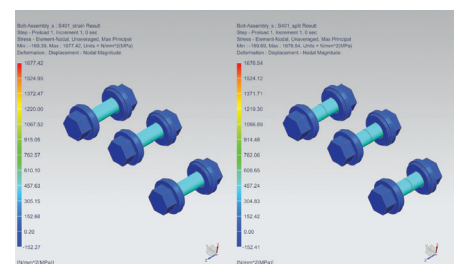

Study bolt pre-loading using the new general-purpose nonlinear solution in NX Nastran.

New in structural dynamics

In this release, Simcenter 3D allows for new reduced model representations that you can use as components in finite element assemblies. You can now use reduced representation models from modal and frequency response function (FRF) data that you have gathered from either physical testing or analytical means. This means you can create hybrid assemblies consisting of data obtained through simulation and physical tests, and can help you simplify OEM/supplier data exchanges.

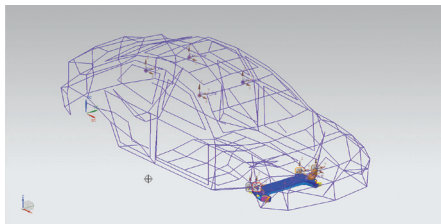

Hybrid modeling combines test and simulation based models for structural dynamics and NVH analysis.

New for flexible pipe simulation

This release of Simcenter 3D introduces a new solution that allows you to perform advanced nonlinear mechanical simulation analyses of various types of flexible hoses and other pipes within the Simcenter 3D environment. The flexible pipe solution can compute the motion cables and hoses that are connected to moving parts – like brake cables in auto suspensions. The Simcenter 3D flexible pipe solution will help you prevent collision of the pipe with other components and reduce wear and fatigue issues by preventing excessive cable bending and torsion.

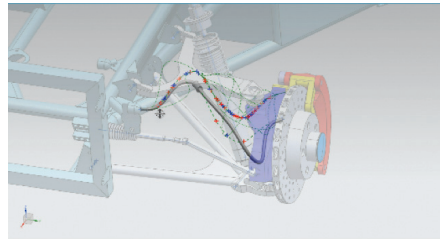

Simulate movement of flexible pipes such as brake hoses in a suspension.

New in flow analysis

The new release includes specific enhancements to the modeling process when using surface wrap for computational fluid dynamics (CFD) and acoustics applications. The new automatic cavity detection function locates cavities within CAD geometries without user intervention. This capability significantly reduces user effort in identifying and wrapping cavities in complex CAD geometry. Additional enhancements to surface wrapping give you more control of wrap resolution.

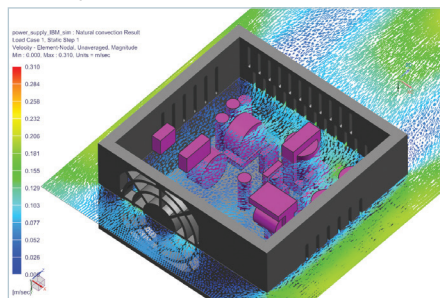

Gain more control over surface wrapping for more accurate flow simulation.

New in pre- and postprocessing

New rule-based selection recipes can help you improve productivity and automate pre- and postprocessing processes. In addition, new universal connections help you automate the process of connecting components into assemblies used for various kinds of analyses. Finally, new discipline-specific postprocessing helps you quickly display and evaluate the results you need for your specific application.

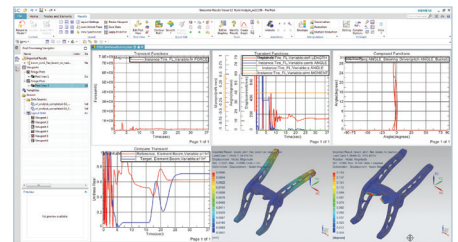

New lightweight results viewer gives decision makers the information they need.

Expanded nonlinear solutions

Many of the engineering problems you face in real-world applications cannot be solved linearly. Hyperelastic materials, large deformations, and contacts require you to use a nonlinear solution instead. A major focus for this release of Simcenter 3D has been to further extend its nonlinear solutions to cover more engineering applications. Nonlinear simulation in Simcenter 3D now offers more elements, greater robustness and algorithms for multi-step nonlinear simulation to provide enhanced realism and faster solution times. These new nonlinear solutions are available in Simcenter's structural solvers, NX Nastran and LMS Samtech Samcef, along with the necessary pre/post enhancements in Simcenter 3D to support those solver solutions.

Multi-step nonlinear solution (NX Nastran SOL 401)

The NX Nastran multistep nonlinear solution (SOL 401) has been broadened to cover models with shells, beams, and spring elements. The broader coverage means the multi-step nonlinear solution can now be used as a general-purpose FE nonlinear solver for problems involving both material and geometrical nonlinear aspects. Additionally, the multi-step nonlinear solution can be coupled with Simcenter 3D Thermal software to perform thermo-mechanical nonlinear analysis, which is ideal for the simulation of turbomachinery and applications with composite materials.

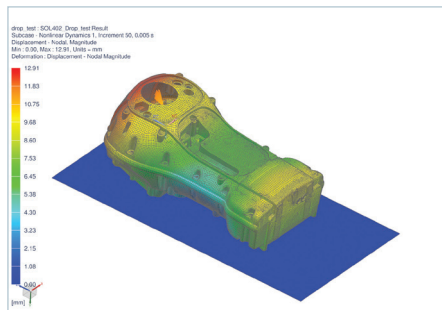

Nonlinear drop test simulation for an electronics device performed using NX Nastran.

Nonlinear dynamics (NX Nastran SOL 402)

A new structural nonlinear dynamics solution has also been introduced into NX Nastran as SOL 402, and is supported from the Simcenter 3D interface. The nonlinear dynamics solution is based on large displacement/large rotation formulation originally available in the Samcef solver, and can be applied to static, quasi-static, kinematic and dynamic simulations of structures.

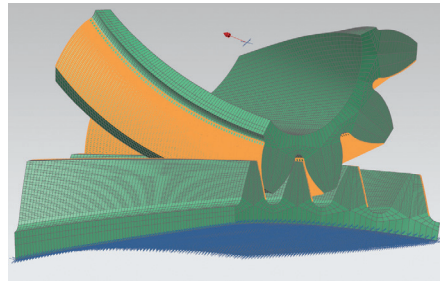

Simulate gear teeth with nonlinear dynamics in NX Nastran.

Samcef environment for composites

Another focus area for Simcenter 3D is on the simulation of composites. The Simcenter 3D environment for the Samcef solver has been enhanced to take full advantage of the unique composite material nonlinear simulation capabilities of LMS Samcef. You can use the environment to design composite structures and apply simple concepts like "first ply damage." In addition to product performance simulation, you can use the LMS Samcef environment to simulate composite manufacturing processes, like the curing process and spring-back effect.

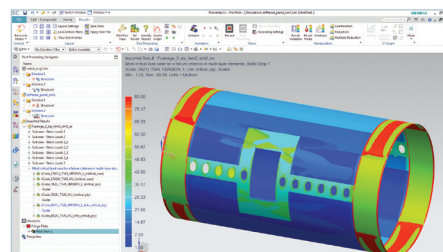

Simulate composites for ply damage.

Enhanced industry workflows

Siemens has decades of experience in industry, and this experience is reflected back in our products. Simcenter 3D is no different. By maintaining close relationships with our customers and through Siemens' own extensive engineering expertise, we learn and develop simulation best practices that make their way into every Simcenter 3D solution. The latest release of Simcenter 3D incorporates new capabilities that enhance industry-specific workflows for airframe, automotive, and spacecraft engineers.

Solutions for airframe engineering

Extending solutions for airframe engineering is a major focus for the latest release of Simcenter 3D. For example, you can now create submechanisms within your full aircraft motion model to include individual working subsystems like landing gear. Composites are also critical to airframe engineering, and with Simcenter 3D you can now more accurately predict how composite material is shaped and performs after its manufacturing processes.

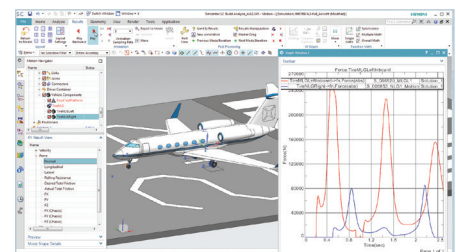

Efficiently assemble large motion models through management and re-use of modular mechanisms

Solutions for automotive engineering

Automotive engineers often have multiple variants of the same finite element assembly for different types of analyses like noise, vibration and harshness (NVH), crash, durability, and more. This can lead to inefficiency and challenges when updating components within each assembly. This Simcenter 3D release introduces new universal connections that work across solvers and analysis types and simplify your process. Additionally, this release of Simcenter 3D includes capabilities to help suspension engineers efficiently model flexible pipes and hoses like brake lines.

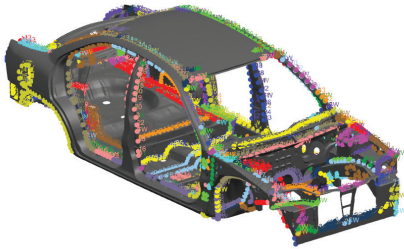

Streamline the creation of large assemblies through automated creation of proximity-based connections

Solutions for spacecraft engineering

Simcenter 3D provides a complete set of in-orbit thermal analysis tools, and this latest release provides enhanced physical modeling of orbital heat transfer. The degradation of surface thermo-optical properties can be effectively modeled by using up to five different values of thermo-optical properties to represent the condition of the spacecraft surfaces from beginning of life (BOL) to end of life (EOL). Further, the variation of planetary heat flux and albedo with longitude and latitude can now be easily defined when computing thermal response of orbiting spacecraft.

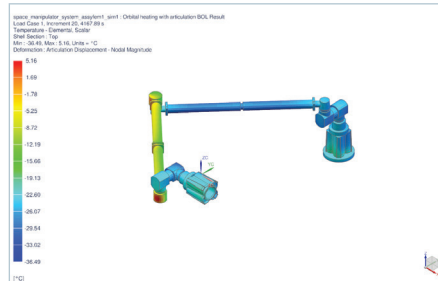

Model the degradation of surface thermo-optical properties

NX 12 for next-generation manufacturing

Transform your part manufacturing with a digital machine shop

NX 12 for Manufacturing offers next-generation tools for computer numerical control (CNC) machining, robotics, additive manufacturing, and quality inspection to enable the digitalization of part manufacturing within a single, integrated, end-to-end system.

NX CAM

New advanced capabilities in NX CAM 12 for mold and die machining, production machining and complex parts machining deliver a new level of automation and efficiency providing powerful advantages to part manufacturers.

Mold and die machining

Adaptive milling is a new high-speed cutting strategy that can reduce machining cycle time by up to 60 percent. This intelligent roughing method enables deep cuts and constant tool load that increase material removal rates while extending tool life. Although ideal for cutting hard materials such as steels used for tooling, adaptive milling can be used for high-speed machining of a range of materials, including production machining of aluminum parts.

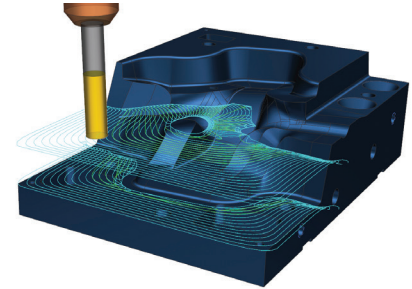

Machine 60 percent faster with adaptive milling, a new high-speed roughing method in NX CAM 12.

This innovative cutting strategy maintains consistent chip thickness by dynamically adjusting the machining parameters, including stepover and feed rate. By maintaining consistent chip thickness, the cutting forces can be significantly reduced, enabling high speeds and feeds using the entire flute length. This gives you an advantage over conventional milling where you can use only a small portion of the flute length for cutting. With Adaptive Milling, you can use high machining speeds, while reducing production costs by extending the cutting tool life.

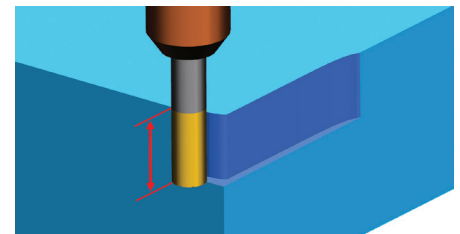

Extend tool life and maximize material removal rate by cutting with the entire tool flute length using adaptive milling.

Enhanced finishing strategies in NX CAM 12 can further improve the quality of a machined surface. The consistent stepover can now be achieved across the entire machined area, regardless of the slope. Also, the intelligent finishing toolpaths can recognize small cavity features in machined surfaces and machine over them, which improves cutting conditions and minimizes part preparation operations.

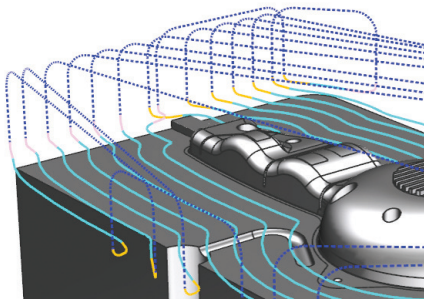

Improve machining accuracy, reduce machining time and minimize the wear of machine tools using the smooth toolpaths in NX CAM 12.

NX CAM software has advanced capabilities to create toolpaths with smooth cutting moves. NX 12 gives you even more control to apply smooth engage, retract and transfer moves. The resulting optimized toolpaths without sharp corners eliminate sudden stops and changes of direction during the machining process. These optimized toolpaths can significantly minimize the wear of machine tools, which increases equipment uptime and reduces production costs.

Production machining

New in NX 12 is NX Machining Line Planner software for high-volume production of complicated parts with many features. NX Machining Line Planner, combined with integrated NX CAM software, enables distribution, balancing, programming and simulation of operations over multiple setups and machines. This integrated solution allows bi-directional change management between programming and line planning. By using a digital twin of complete machining lines to optimize the process, automotive and machinery manufacturers can reduce planning time and increase throughput.

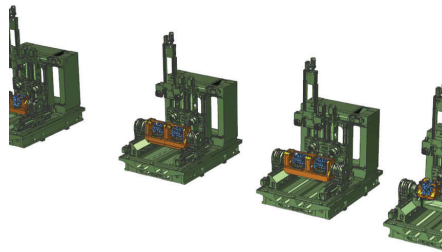

Plan and optimize high-volume flexible machining lines using NX Machining Line Planner. Program detailed NC operations using integrated NX CAM.

For programming of multi-function machines, keeping track of the in-process state of the workpiece is a critical capability. The seamless transfer of the in-process workpiece (IPW) between milling, drilling and turning operations enables accurate visualization of the complete machining process. The enhanced IPW capabilities also enable you to identify possible collisions between the in-process workpiece and tool holders. With these new capabilities, you can quickly create optimized and safe toolpaths to take full advantage of the latest mill-turn machines.

Complex parts machining

Five-axis machining in NX enables you to produce precision complex parts with fewer operations and setups – reducing cost and delivery times. NX CAM 12 introduces new advanced capabilities that streamline the NC programming while creating efficient multi-axis toolpaths.

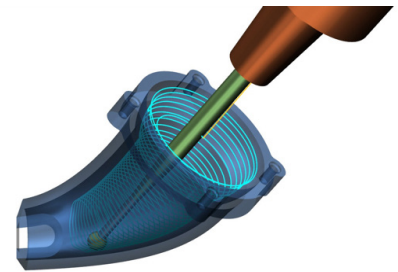

Easily create error-free 5-axis roughing and finishing operations with tube milling in NX CAM 12

The new tube milling 5-axis capabilities drastically simplify programming of hollow and narrow features, including ports of engine blocks. Programming these features using conventional methods can be very time-consuming and prone to errors that result in machine downtime on the shop floor. Tube milling streamlines the NC programming process and allows you to eliminate preparation and minimize input of parameters. These efficient roughing and finishing operations ensure high-speed and error-free 5-axis milling that improves machined surface quality.

Robotics for part manufacturing

In the previous release of NX, new robotic machining capabilities were introduced. Using NX CAM robotics machining, you can program robots to perform precise machining-type tasks including trimming, de-burring, grinding, and polishing.

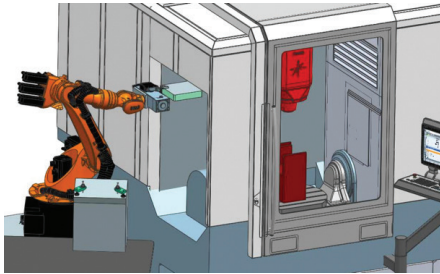

Automate part manufacturing by using NX CAM to program robots for CNC machining operations and machine tending.

The robotic machining in NX CAM 12 was significantly enhanced by a virtual teach mode technology. This allows the user to easily program a robot to do pick-and-place operations, including machine tending and tool loading.

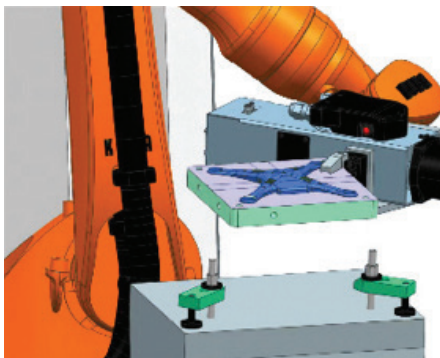

Use NX CAM robotics programming to automate part manufacturing. A robot performs pick-and-place operation. (right) The same robot performs machining.

By combining NX CAM software with the embedded Virtual NC Controller Kernel (VNCK) from Siemens' Sinumerik 840D SL controller, you can achieve a new level of accuracy and completeness when using 3D simulations to validate robot motions.

With the new robotics programming capabilities in NX CAM, you can program robots to perform CNC machining and pick-and-place operations using one system, enabling you to further automate your part manufacturing process.

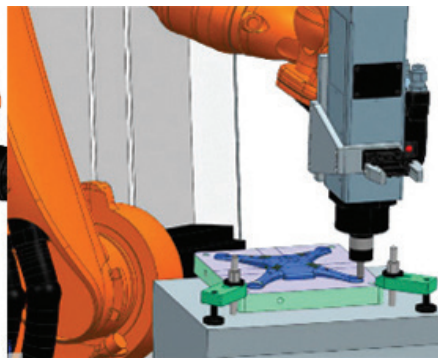

NX Additive Manufacturing

Industrialize additive manufacturing with NX 12.

Powder bed printing

Powder bed printers remain the most popular option for printing metal parts and NX 12 now has a robust, integrated connection with these printers.

This new module, powered by Materialise technology, includes facilities for creation of support structures as well as for the setup of the build tray, positioning and patterning of parts in the build tray, and a build processor framework for connection to powder bed printers.

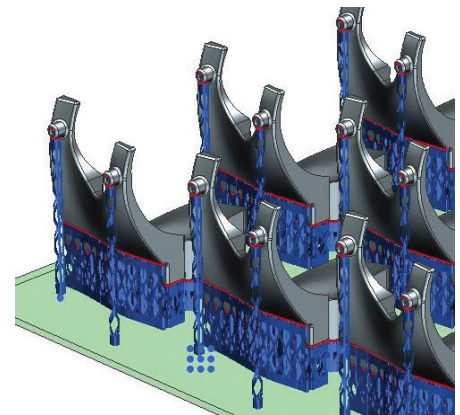

Automatically create various support structure types (powered by Materialise) for use with powder bed printers using the new NX Additive Manufacturing Fixed Plane Basic module.

With NX 12 you can set up, connect, and print with powder bed printers all in a single system, meaning you can now have a single, uninterrupted digital thread from design to print.

HP Multi Jet Fusion printers

The landscape for printing plastic is evolving as new vendors are entering the industry. One exciting new addition to the hardware landscape for plastic printers is HP with their Multi Jet Fusion technology.

NX 12 has a new module, certified by HP and powered by Materialise, that enables customers to design, optimize, simulate, prepare print jobs and inspect processes for HP Multi Jet Fusion 3D printers. NX users can load multiple models, automatically nest the models in 3D, and submit the job to HP 3D printers in a single NX environment and with a minimum number of steps.

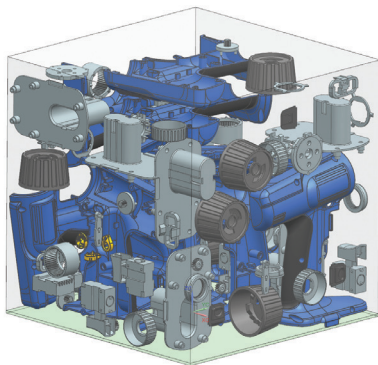

Easily nest multiple parts (powered by Materialise) in the build area to optimize the efficiency of printing on HP Multi Jet Fusion printers.

When HP's new 3D printers are combined with the power of Siemens NX, printing of plastic parts is easier, faster and more accurate than ever before.

NX CMM Inspection Programming 12

NX CMM Inspection Programming enables programming of CMM machines, as well as visualization and analysis of measurement data in the NX graphical environment.

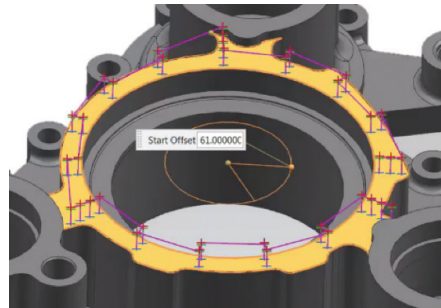

Quickly create inspection paths in circular patterns using NX CMM Inspection Programming 12.

The new feature-specific inspection programming functions in NX 12 enable you to easily create point sets in circular patterns. New capabilities also allow you to import Dimensional Measuring Interface Standard (DMIS) inspection programs in NX to create inspection setups and generate touch trigger programs with minimum input. This capability enables Robcad CMM users to transition easily to NX CMM. In addition, you can now use NX CMM Inspection Programming to analyze measurement data acquired by laser or white light scanner devices.

Siemens PLM Software
www.siemens.com/plm

Americas +1 314 264 8499
 Europe +44 (0) 1276 413200
 Asia-Pacific +852 2230 3308



844-GEO-SUPT
support@geoplms.com
geoplms.com

© 2018 Siemens Product Lifecycle Management Software Inc. Siemens, the Siemens logo and SIMATIC IT are registered trademarks of Siemens AG. Camstar, D-Cubed, Femap, Fibersim, Geolus, GO PLM, I-deas, JT, NX, Omneo, Parasolid, Solid Edge, Syncrofit, Teamcenter and Tecnomatix are trademarks or registered trademarks of Siemens Product Lifecycle Management Software Inc. or its subsidiaries in the United States and in other countries. All other trademarks, registered trademarks or service marks belong to their respective holders. 67350-A6 12/17 P